

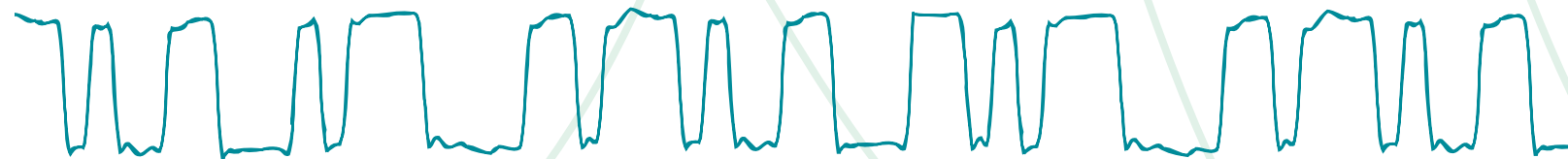

WAVECREST

OE-2

Optical to Electrical Converter



OE-2

Fast and Accurate Testing

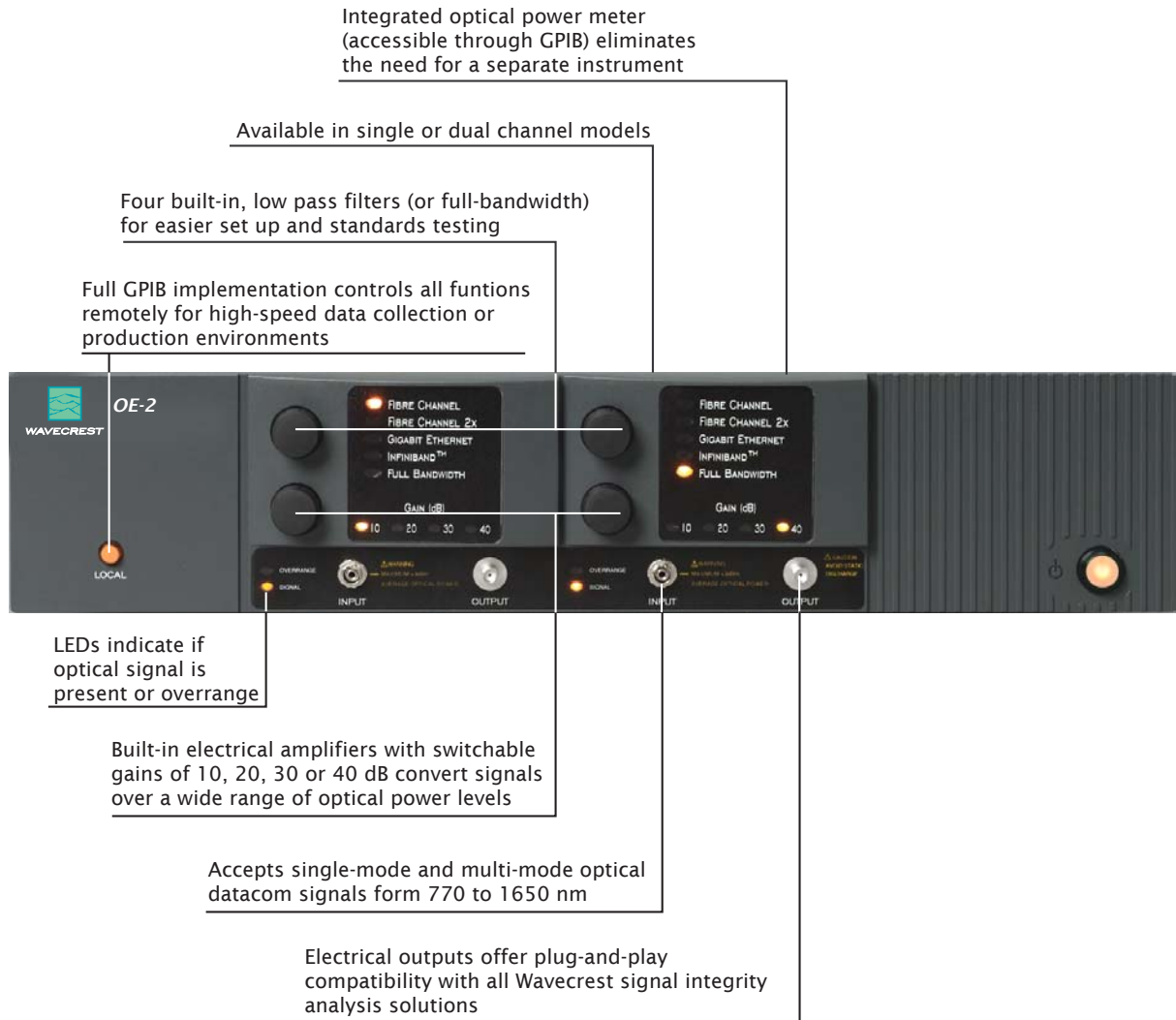

The most powerful optical testing solution available

With optical data rates increasing at an unprecedented pace, guaranteeing optical signal integrity has never been more critical. That's why we developed the Wavecrest OE-2.™

This optical-to-electrical converter connects seamlessly with the Wavecrest SIA Family of Signal Integrity Analysis solutions, and eliminates the need for separate power meters, filters and amplifiers.

The result is an industry first - a complete optical testing solution that:

- ◆ Performs comprehensive optical signal characterization
- ◆ Tests optical signals faster than any other instrument available
- ◆ Achieves full jitter compliance to Gigabit Ethernet and Fibre Channel standards
- ◆ Measures jitter crosstalk in 10 to 40 Gb/s multi-lane optical systems



OE-2 shown with a Wavecrest SIA Signal Integrity Analysis solution

Comprehensive Signal Integrity Analysis

Built-in Power Meter

- ◆ Lowers investment cost as no additional equipment is needed
- ◆ Reduces errors associated with connecting to multiple instruments

Built-in Linear Amplifiers

- ◆ Enables amplification of converted optical signal up to 40 db

4th Order Bessel T. Filters

- ◆ Eliminates need for custom filters
- ◆ Allows exact frequencies to be ordered, four per channel
- ◆ Enables cleaner signal because no external parts are added to signal path
- ◆ Best step response

Internal Calibration Routine Across All Filters

- ◆ Ensures that the electrical signal very closely represents the optical signal
- ◆ Saves time and money when calibrating as unit does not need to be sent back to factory

Temperature Controlled Detector

- ◆ Ensures optical parameters are thermally stable, enabling more accurate readings

Integrates into a Wavecrest SIA

- ◆ Provides full set of diagnostic tools

Complete optical signal characterization

The OE-2 enables high-speed design, debug, characterization and production testing of optical signals in Gigabit Ethernet, Fibre Channel, OC-48, SONET, Parallel 10 Gigabit Ethernet (LX4 and SX4) and InfiniBand applications. It is a fully integrated, calibrated instrument, featuring four low-pass filters, four switchable amplifiers, and an optical power meter.

Superior speed for design and production

The OE-2 allows you to measure rise time, fall time, extinction ratio (ER), optical modulation amplitude (OMA), average optical power and all jitter components on optical signals. In other words, it helps you diagnose and correct defects early in design - so you can accelerate the transition to production. Plus, it enables you to make critical performance measurements up to 10 times faster than with an oscilloscope. By testing more components in less time, you can shorten time-to-market, increase manufacturing throughput and reduce cost-of-test.

Comprehensive optical jitter analysis

Wavecrest jitter analysis tools use patented algorithms to make standards-compliant measurements of total and deterministic jitter. You can isolate deterministic, random and periodic jitter components, and identify specific jitter contributions to find the root cause. These capabilities provide a more precise picture of optical signals, so you can optimize manufacturing, resolve potential issues faster, and guarantee standards compliance.

Measure jitter crosstalk in 10 Gb/s multi-lane optical systems

Jitter crosstalk occurs between channels of parallel optical communication systems - such as 10 Gigabit Ethernet, VSR and other multi-lane optical interfaces - with individual transmission signals running at speeds up to 3.125 Gb/s. Using the OE-2 with an SIA Signal Integrity Analysis solution allows you to analyze jitter crosstalk in these and other applications - something no other instrument can do.

Performance Specifications

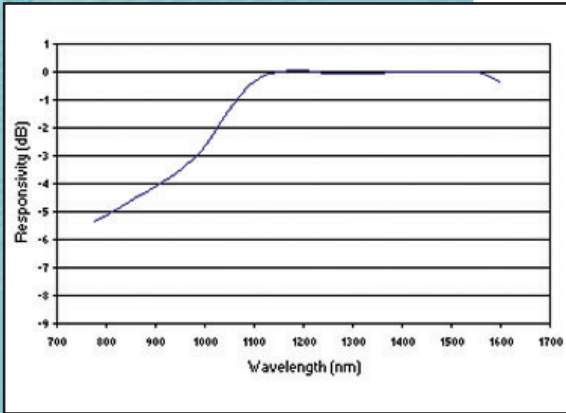

Typical OE-2
Responsivity vs. Wavelength

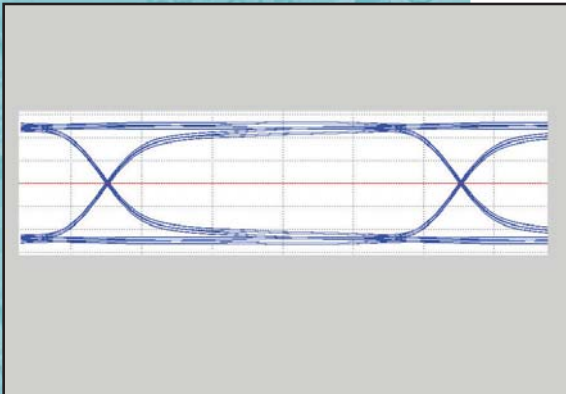

Eye Diagram, Infiniband (2.5 GBS),
PRBS, 1.3% ISI

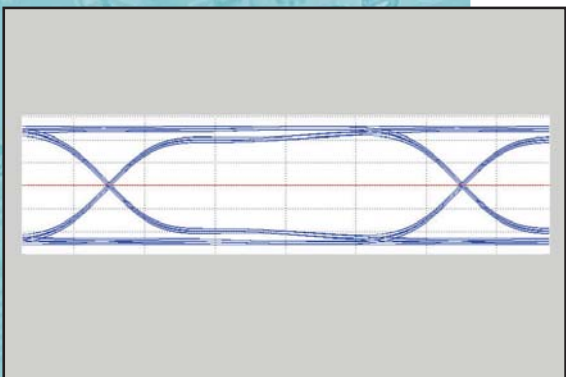

Eye Diagram, FC4x, 1.6% ISI

Optical Characteristics

Wavelength Range	770-1650 nm
Conversion Gain (850 nm) ^{1,2}	5,500 V/W
Conversion Gain (1550 nm) ^{1,2}	20,000 V/W
Maximum Input Level ³	+3 dBm
Input Damage Level	>+10 dBm
Polarization Dependent Loss ⁴	<0.1 dB
Input Return Loss ⁴	>20 dB
Input Connector Type	FC/UPC Multimode
Input Connector Core Diameter	62.5 μm
Optical Power Meter Accuracy ⁵	±0.5 dB

Electrical Characteristics

Input Data Rate	155 Mb/s to 4.5 Gb/s
Frequency Response ^{1,6,7,8}	100 KHz - 4.5 GHz
Passband Ripple ^{1,6,7,8}	±1 dB
Rise Time (10-90%) ^{1,6,8,9}	90 ps
Intersymbol Interference ^{1,10}	<3 of UI
Filter Response	4 th Order Bessel-Thompson
Output Impedance	50Ω nominal
Output Return Loss ¹	>15 dB typical
Output Connector	SMA

Notes:

1. Typical value.
2. With maximum amplifier gain selected.
3. Peak operational signal level.
4. Measured in Single Mode fiber.
5. Over the range of -18 to +3 dBm at 850 nm or over the range of -22 to +3 dBm for 1550 nm operation
6. Measured by 650 fs (FWHM) mode-locked laser impulse.
7. Calculated -3 dB frequency response from an FFT of impulse response.
8. Full Bandwidth, 20 dB amplifier positions selected.
9. Measured with 20 GHz oscilloscope.
10. Peak-to-Peak ISI contribution simulated from mode locked laser response using a 2.5 Gb/s PRBS 27-1 pattern with the Infiniband filter and 20 dB amplifier positions selected.

Calculated Measurement Accuracy

Extinction Ratio¹¹ ±1 dB
 Optical Modulation Amplitude^{11,12} ±12%

Notes:

11. Using an SIA Signal Integrity Analysis solution, A45 Channel Card, Gigaview software with a 100-125 MHz square wave, 850 nm, average optical power level of -5 dBm (per Fibre Channel or Gigabit Ethernet standards)
12. Percent of reading.

Environmental Requirements

Operating Temperature +15 to +35°C
 Storage Temperature. -40 to +55°C
 Operating Humidity 0-85% non-condensing

Miscellaneous Characteristics

Calibration Interval 1 year
 AC Voltage 90-264 VAC
 AC Frequency 50/60 Hz

Low Pass Filter Response Characteristics

OE-2 Opt. 1	OE-2 Opt. 5	Standard	Design Cut-off Frequency
◆	◆	Fibre Channel 1x	797 MHz
◆	◆	Fibre Channel 2x	1.594 GHz
	◆	Fibre Channel 3x	2.3906 GHz
	◆	Fibre Channel 4x	3.1875 GHz
◆		Gigabit Ethernet	937.5 MHz
◆		Infiniband	1.875 GHz

Notes:

- A. Typical measurements provide non-warranted information about system performance or capabilities.
- B. Wavcrest continually engages in research related to product improvement. New material, production methods, and design refinements are introduced into existing products without notice as a routine expression of that philosophy. For this reason, the OE-2 may differ in some respect to the specifications stated in this document.
- C. The OE-2 will comply with these specifications after a 30-minute warm-up period.

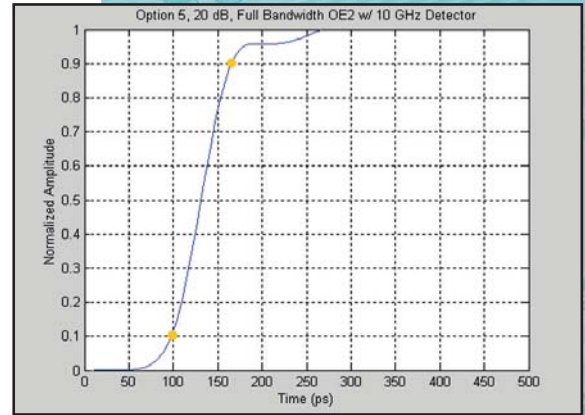

OE-2 Option 5, 20 dB, Full Bandwidth:
 Rise Time 10-90%: 68 ps, Rise Time 20-80%: 44 ps

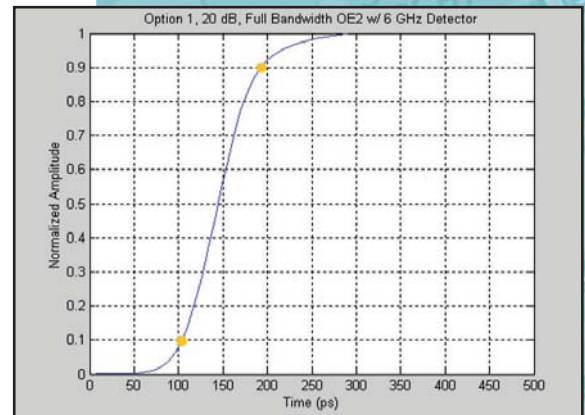

OE-2 Option 1, 20 dB, Full Bandwidth:
 Rise Time 10-90%: 89 ps, Rise Time 20-80%: 56 ps

OE-2 Block Diagram

Single channel shown

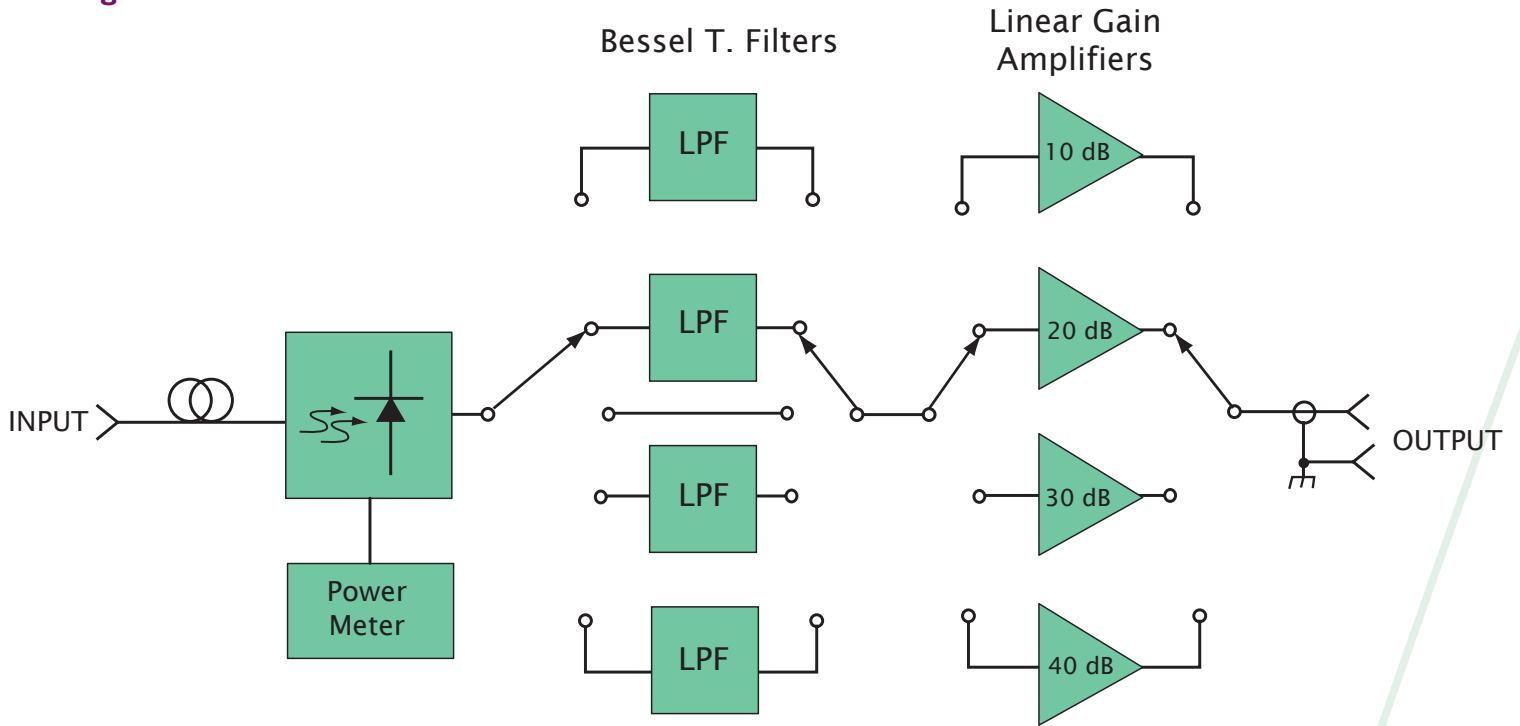

WAVECREST

Be certain of the signal you send.

7626 Golden Triangle Drive
Eden Prairie, MN 55344
Phone: 952.831.0030 Fax: 952.831.4474
www.wavecrest.com

Wavecrest San Jose
408.436.9000

Wavecrest Europa GmbH
49.89.32225330

Wavecrest K.K.
81.3.5960.5770

